

S.E Green SE series AGM batteries are designed to have a large amount of stored current discharged between charging sessions, with very heavy non-porous battery plates to withstand repeated major discharging and charging cycle. The S.E Green VRLA AGM battery uses a different chemistry for the plates active paste material, and a slightly stronger electrolyte than normal battery electrolyte, thus the SE range features higher cyclic life with 10 years of float life when compared to the standard Duration range.

12V
Voltage

35Ah
Capacity

AGM
Technology

VRLA
Battery



COMPLIED STANDARDS



GENERAL FEATURES

- 30% more cyclic life through innovation at the PAM additives
- Long life expectancy of 10 years in floating condition
- Thick flat plate with high Tin low Calcium alloy
- Excellent deep discharge recovery capability
- Deep cycle performance: up to 700 cycles @ 50% DOD

APPLICATIONS

- Telecom Control Equipments
- UPS systems, Inverter
- Power Equipments
- Standby backup
- Emergency Power Systems

DIMENSIONS & WEIGHT

Length(mm/inch)	196/7.72
Width(mm/inch)	130/5.12
Height(mm/inch)	155/6.11
Total Height(mm/inch)	167/6.58
Weight(kg/lbs)(±3%)	10/22.1

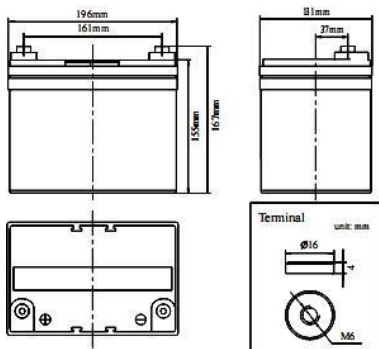

TECHNICAL SPECIFICATIONS

Nominal Voltage		12V(6 cells per unit)
Design Floating Life @25°C		8 Years
Nominal Capacity @25°C (10 hour rate@3.50A,10.8V)		35Ah
Capacity @25°C	20hour rate (1.9A,10.8V)	38.0Ah
	5 hour rate (6.4A,10.5V)	32.0Ah
	1 hour rate (23.3A,9.6V)	23.3Ah
Internal Resistance	Full Charged Battery@25°C	≤10.0mΩ
Ambient Temperature	Discharge	-15°C~45°C
	Charge	-15°C~45°C
	Storage	-15°C~45°C
Max.Discharge Current@25°C		210A (5s)
Capacity affected by Temperature (10 hour)	40°C	105%
	25°C	100%
	0°C	85%
	-15°C	65%
Self-Discharge@25°C per Month		3%
Charge (Constant Voltage) @25°C	Standby Use	Initial Charging Current Less than 8.75A Voltage 13.6-13.8V
	Cycle Use	Initial Charging Current Less than 8.75A Voltage 14.4-14.9V

BATTERY DISCHARGE TABEL

Discharge Constant Current per Cell (Amperes at 25°C)

F.V/Time	15min	30min	45min	1h	2h	3h	5h	8h	10h	20h
1.60V	59.1	36.7	26.3	23.3	14.2	10.4	6.7	4.4	3.9	2.3
1.65V	56.6	35.8	25.7	22.7	13.9	10.2	6.6	4.3	3.8	2.2
1.70V	54.2	34.8	25.0	22.0	13.6	10.0	6.5	4.2	3.7	2.1
1.75V	51.7	33.8	24.2	21.4	13.4	9.8	6.4	4.1	3.6	2.0
1.80V	49.3	32.8	23.6	20.8	13.0	9.5	6.3	4.0	3.5	1.9

Discharge Constant Power per Cell (Watts at 25°C)

F.V/Time	15min	30min	45min	1h	2h	3h	5h	8h	10h	20h
1.60V	119.7	74.5	53.4	47.1	28.7	21.0	13.5	8.3	7.5	4.3
1.65V	114.7	72.5	52.0	45.9	28.2	20.6	13.3	8.2	7.4	4.2
1.70V	109.7	70.5	50.6	44.6	27.7	20.2	13.1	8.1	7.3	4.1
1.75V	104.7	68.5	49.1	43.4	27.0	19.8	12.9	8.0	7.2	4.0
1.80V	99.7	66.5	47.7	42.1	26.4	19.3	12.8	7.9	7.1	3.9

Note: The above data are average values, and can be obtained within 3 charge/discharge cycles. These are not minimum values. Cell and battery designs/specifications are subject to modification without notice.

PERFORMANCE CHARACTERISTICS

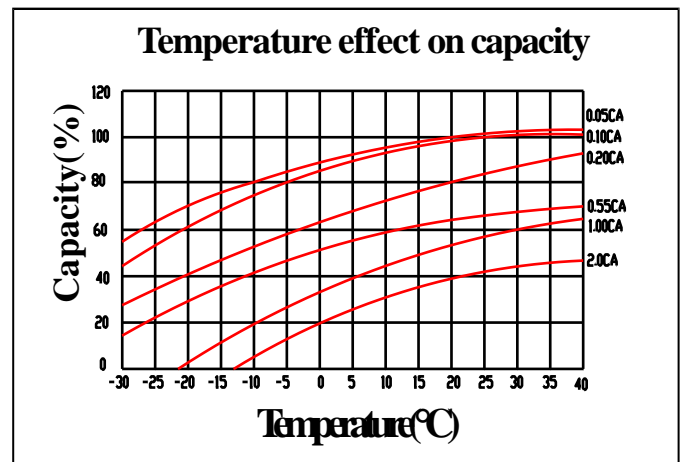
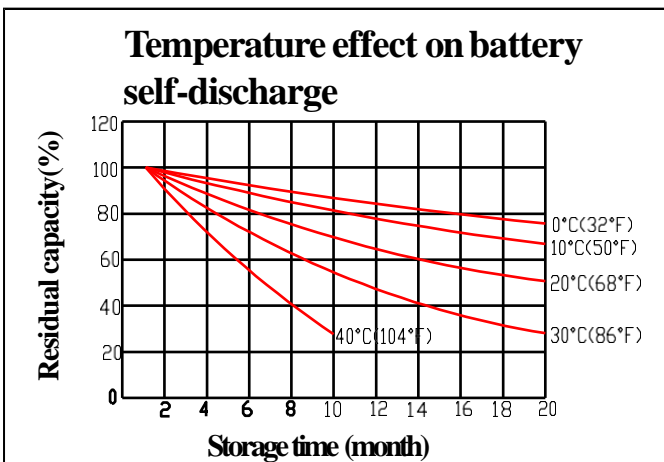
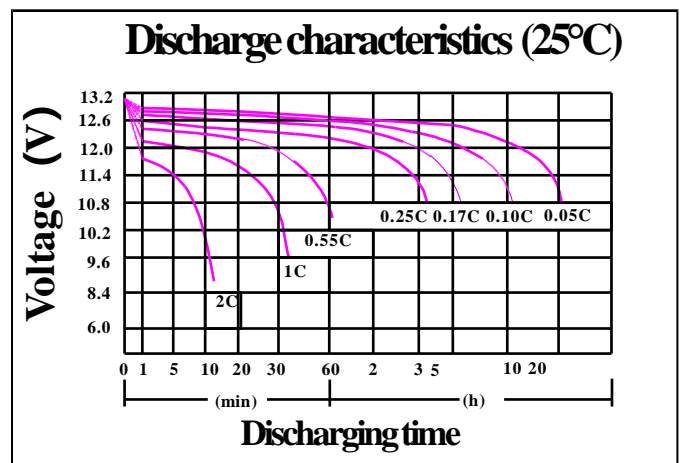
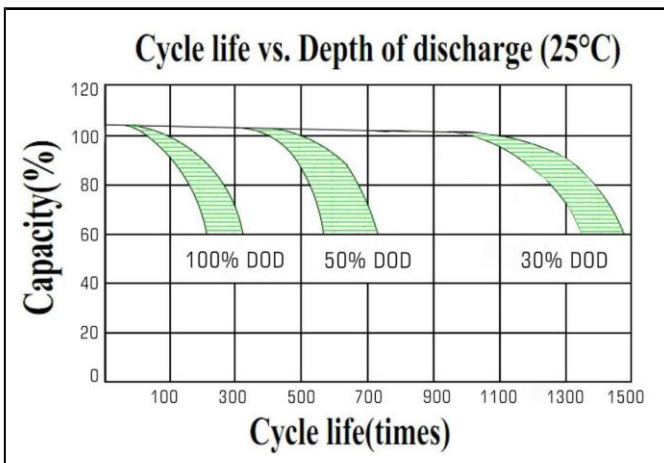
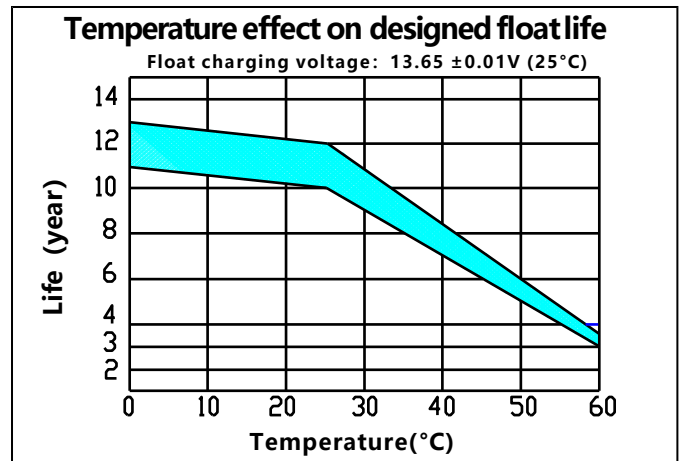
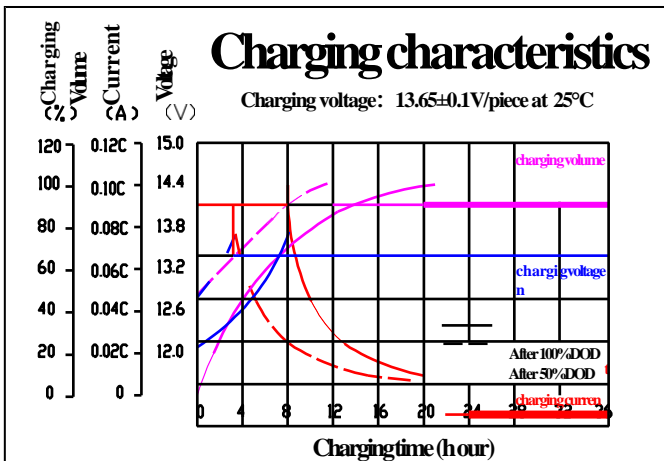

BATTERY CONSTRUCTION

Component	Positive plate	Negative plate	Container & Cover	Safety valve	Terminal	Separator	Electrolyte	Pillar seal
Features	Thick high Sn low Ca grid with special paste	Balanced Pb-Ca grid for improved recombination efficiency	Fire resistance ABS (UL94-V0)	Flame Si-Rubber and aging resistance	Female Copper Insert M6	Advanced AGM separator for high pressure cell design	Dilute high purity sulfuric acid	Two layers epoxy resin seal